

19*40W MOVING HEAD BEEHIVE

INSTRUCTION MANUAL



INDEX

Page	Contents
1	Specifiation
2	Safety information
4	Unpacking and package
5	Start up
6	Control panel
8	Cause and solution of problems
8	Menu setting
16	Channel functions

Congratulations on choosing our product!

We thank you for your custom.

Please note that this product, has been designed and made with total quality to ensure excellent performance and best meet your expectations and requirements.

Carefully read this instruction manual in its entirety and keep it safe for future reference. It is essential to know the information and comply with the instructions given in this manual to ensure the fitting is installed, used and serviced correctly and safely.

Up disclaims all liability for damage to the fitting or to other property or persons deriving from installation, use and maintenance that have not been carried out in conformity with this instruction manual, which must always accompany the fitting.

Up reserves the right to modify the characteristics stated in this instruction manual at any time and without prior notice.

Features
No1:4-60 degree electroic zoom range
No2:Bi-directional rotating front lens
No3:Wash,beam kaleido effect
No4:0-100% liner
Product Description

Specification
Input voltage 100-240v/50-60hz
Power Consumption 800W
Lamp 19 Ostar RGBW leds
Led Nominal wattage 40W
Led life 50000hours
Channels 21/35/78/92/97 CH
White CT emulation 2500-8000k
Pan/tilt resolution 16bit
Dimmer resolution 16bit
DMX Protocol signal DMX 512
DMX signal connection 3&5pin inout and output
Display Lcd display
Strobe 1-25flash/s
N.W 18KG

Fuction and effects
Three operating modes:wash,beam,FX(kaleido effects)
Bi-directional Rotating front lens
Digital wash-beam franing effect
Beam edge softening control(in wash mode)
Pixel patterning macros with enhanced control
0-100% linear electronic dimmer
Adjustable speed stop/strobe effect,with instantaneous blackout
Dedicated channel for color temperature setting

SAFETY INFORMATION

• Installation

Make sure all parts for fixing the projector are in a good state of repair.

Make sure the point of anchorage is stable before positioning the projector.

The safety chain must be properly hooked onto the fitting and secured to the framework, so that, if the primary support system fails, the fitting falls as little as possible.

If the safety chain gets used, it needs to be replaced with a genuine spare.

• Minimum distance of illuminated objects

The projector needs to be positioned so that the objects hit by the beam of light are at least 0.20 metres (8") from the lens of the projector.

• Minimum distance from flammable materials

The projector must be positioned so that any flammable materials are at least 0.20 metres (8") from every point on the surface of the fitting.

• Mounting surfaces

It is permissible to mount the fitting on normally flammable surfaces.

• Maximum ambient temperature

Do not operate the fixture if the ambient temperature (T_a) exceeds 40° C (104° F).

• IP20 protection rating

The fitting is protected against penetration by solid bodies of over 12mm (0.47") in diameter (first digit 2), but not against dripping water, rain, splashes or jets of water (second digit 0).

• Protection against electrical shock

Connection must be made to a power supply system fitted with efficient earthing (**Class I** appliance according to standard EN 60598-1). It is, moreover, recommended to protect the supply lines of the projectors from indirect contact and/or shorting to earth by using appropriately sized residual current devices.

• Connection to mains supply

Connection to the electricity mains must be carried out by a qualified electrical installer. Check that the mains frequency and voltage correspond to those for which the projector is designed as given on the electrical data label. This label also gives the input power to which you need to refer to evaluate the maximum number of fittings to connect to the electricity line, in order to avoid overloading. A.leda B-EYEK20: the user must determine, in consultation with the supply authority, that the equipment is connected only to a supply with a maximum permissible system impedance Z_{max} , at the interface point of the user's supply, equal to 0.29 Ω or less.

• Temperature of the external surface

The maximum temperature that can be reached on the external surface of the fitting, in a thermally steady state, is 90° C (194° F).

• Maintenance

Before starting any maintenance work or cleaning the projector, cut off power from the mains supply.

• Light collimation system

This product contains internal light collimation system. Avoid intense light from any angle.

• Photobiological Safety

CAUTION. Possibly hazardous optical radiation emitted from this product. Do not stare at operating lamp. May be harmful to the eyes.

This product is intended for the following areas of application:

studios, stages, theaters, exhibitions, trade fairs, events, theme parks, entertainment venues, architectural lighting and similar

Not suitable for household illumination

Not for residential use

LED  0.2m



t_a 40°C

IP20



t_c 90°C



Risk Group 2
According to
EN 62471





• **Battery**

This product contains a rechargeable lead-acid or lithium iron tetraphosphate battery. To preserve the environment, please dispose the battery at the end of its life according to the regulation in force.



The products to which this manual refers comply with the European Directives pursuant to:

- CE Certificate
- ROHS Certificate
- EMC report
- LVD report

1

Accessories for each light



Packing contents



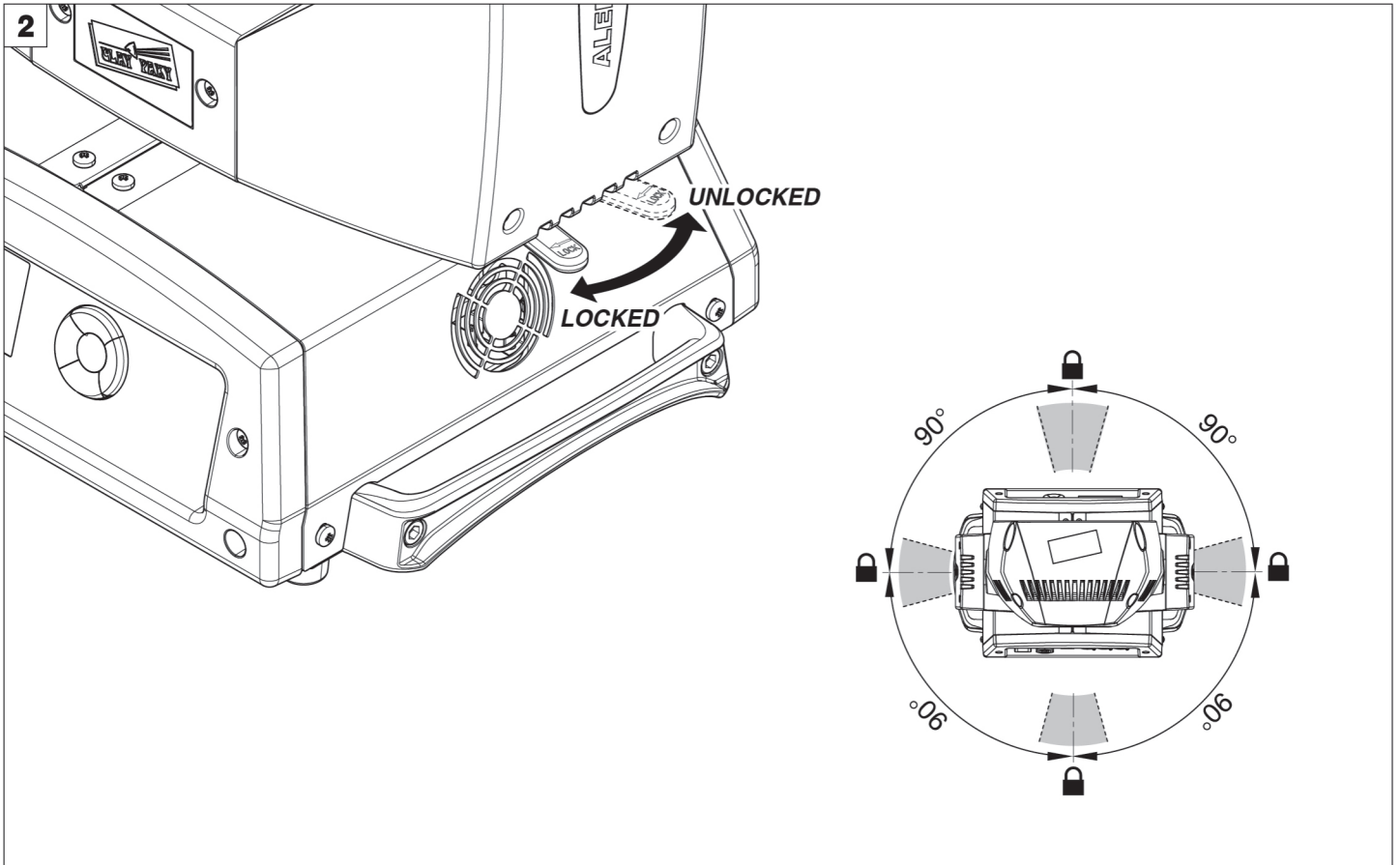

PAN Mechanism Lock and Release (every 90°)

INSTALLATION AND START-UP

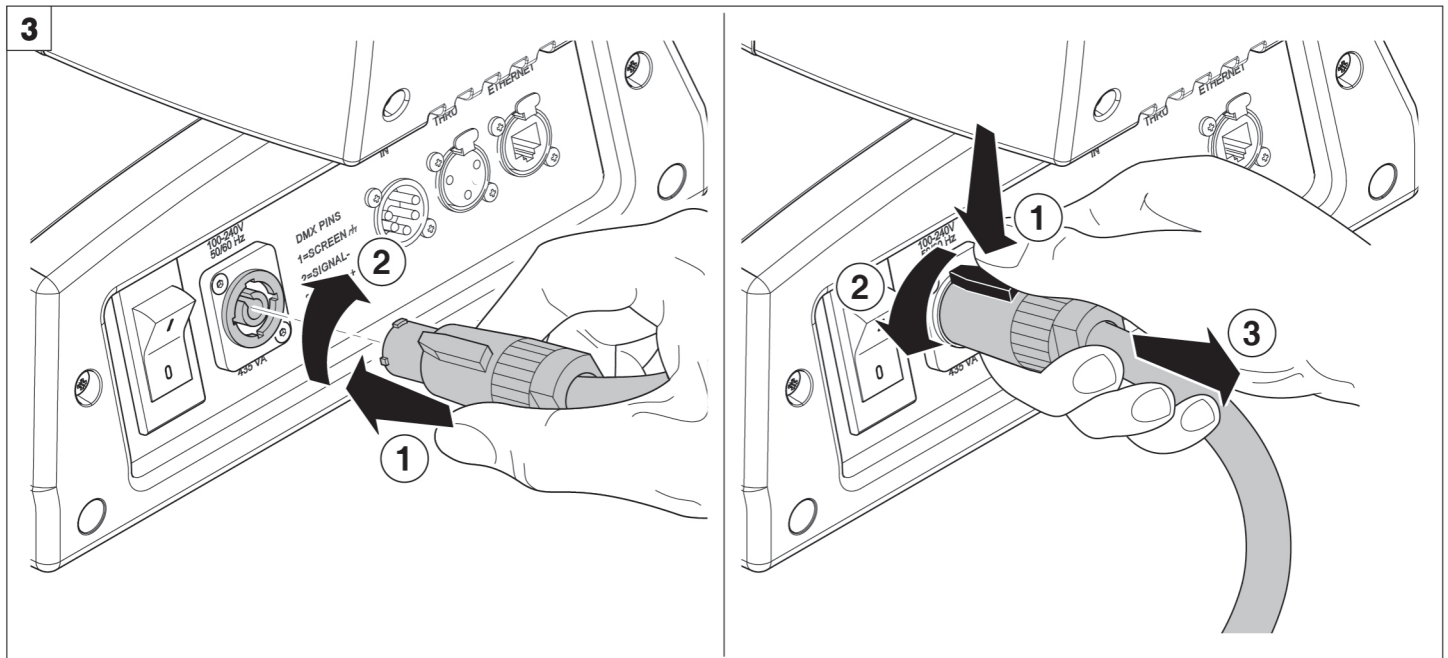

Connecting and disconnecting power cable - Fig. 3

CONTROL PANEL

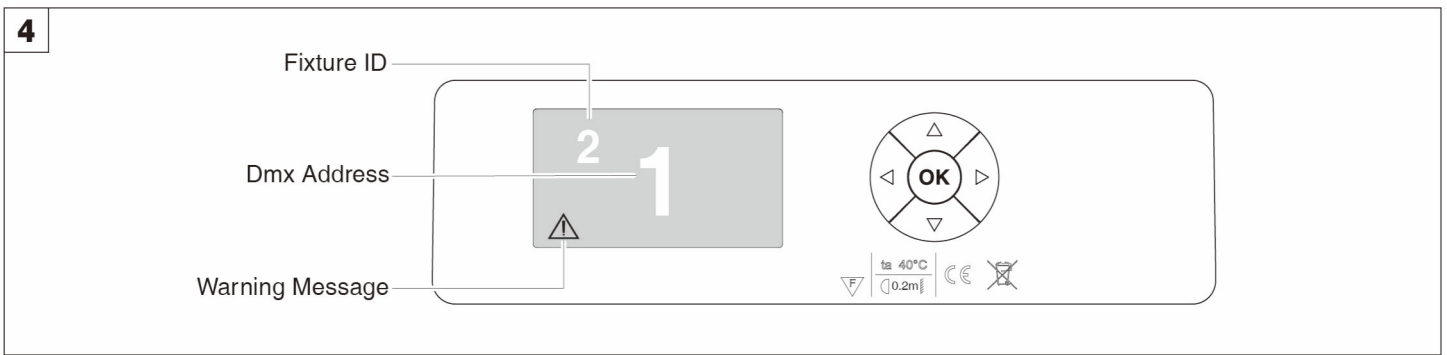

Switching on the projector - Fig. 4

Press the switch. The projector starts resetting the effects. At the same time,

On conclusion of resetting in case of absence of the dmx signal, Pan and Tilt move to the "Home" position (Pan 50% - Tilt 50%). The control panel (Fig. 4) has a display and buttons for the complete programming and management of the projector menu. The display can be in one of two conditions: rest status and setting status. When it is in the rest status, the display shows the projector's DMX address and the Fixture ID address (if set).

During menu setting status, after a wait time (about 30 seconds) without any key having been pressed, the display automatically returns to rest status. It should be noted that when this condition occurs, any possible value that has been modified but not yet confirmed with the **OK** key will be cancelled.

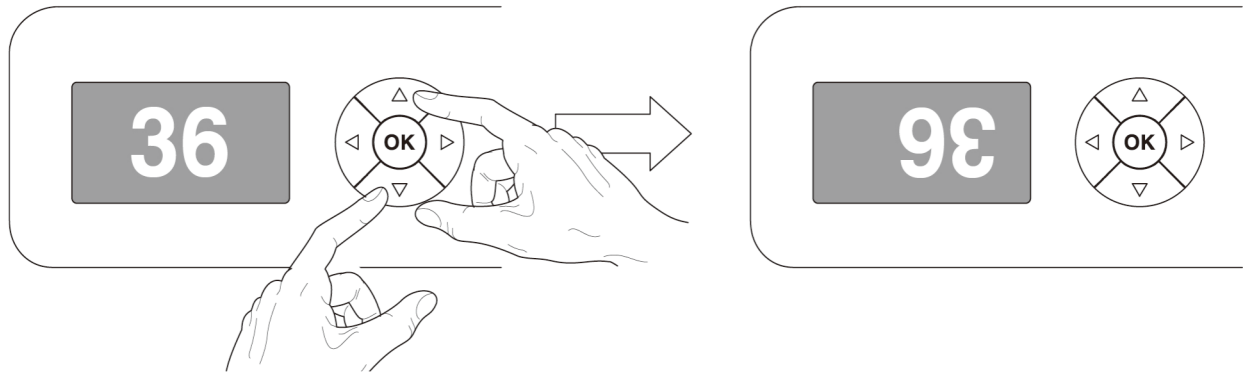

Reversal of the display - Fig. 5

To activate this function, press UP ▲ and DOWN ▼ keys simultaneously while the display is in the rest mode. This status will be memorised and maintained even for the next time it will be switched on. To return to the initial state, repeat the operation all over again.

Setting the projector starting address

On each projector, the starting address must be set for the control signal (addresses from 1 to 512).

The address can also be set with the projector switched off.

Setting the address: see pag. 11.

Setting the projector Fixture ID

On each projector, the Fixture ID address must be set for an easy identification of the fixtures in an installation (ID from 1 to 255).

The Fixture ID address can be set with the projector switched off.

Setting the Fixture ID: see pag. 11.

Functions of the buttons - Using the menu

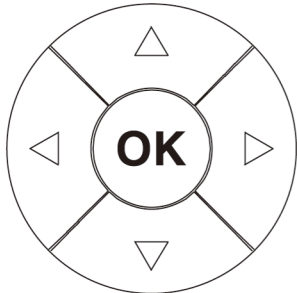

Confirms the displayed value, or activates the displayed function, or enters the successive menu.



DOWN

Decreases the value displayed (with auto-repetitions) or passes to the next item in the menu.



UP

Increases the value displayed (with auto-repetitions) or passes to the previous item in a menu.



LEFT

Return to the top level.



RIGHT

Commute from units, tens, hundreds, in the "Address", "Fixture ID" and "Calibration" menu.

USING THE MENU:

- 1) Press **OK** once – "Main Menu" appears on the display.
- 2) Use the UP ▲ and DOWN ▼ keys to select the menu to be used:
 - Setup (Setup Menu): To set the setting options.
 - Option (Option Menu): To set the operating options
 - Informations (Informations Menu): To read the counters, software version and other information.
 - Manual Control (Manual control Menu): To trigger the test and manual control functions.
 - Test (Test Menu): To check the proper functioning of effects
 - Advanced (Advanced Menu): Access to the "Advanced menu" is recommended for a trained technical personnel.

To enable the "Advanced" see pag. 15.
- 3) Press **OK** to display the first item in the selected menu.
- 4) Use the UP ▲ and DOWN ▼ keys to select the MENU items.

Setting addresses and options with the projector disconnected

The projector's DMX address, as well as other possible operating options, can also be set when the appliance is disconnected from the electricity supply. All that is needed is to press **OK** to momentarily activate the display and thus access the settings. Once the required operations have been carried out, the display will switch off again after a wait time of 30 seconds.

CAUSE AND SOLUTION OF PROBLEMS

THE PROJECTOR WILL NOT SWITCH ON			PROBLEMS
ELECTRONICS NON-OPERATIONAL			
DEFECTIVE PROJECTION			
REDUCED LUMINOSITY			
POSSIBLE CAUSES		CHECKS AND REMEDIES	
●		No mains supply.	Check the power supply voltage.
●	●	LED exhausted or defective.	Call an authorised technician.
●		Signal transmission cable faulty or disconnected.	Replace the cables.
●		Incorrect addressing.	Check addresses (see instructions).
●		Fault in the electronic circuits.	Call an authorised technician.
	●	Lenses or reflector broken	Call an authorised technician.
	● ●	Dust or grease deposited.	Clean (see instructions).

MENU SETTING

XXX = default value

Main Menu	Level 1	Level 2	Level 3	Choices / Values
SET UP	Basic Engine	Mode		Standard Shape
		Source		DMX Art-net
		Universe		0 - 255
		DMX Address		1 - 512
	Pixels Engine	Mode		Disabled RGB RGBW
		Source		DMX Art-net
		Universe		0 - 255
		DMX Address		1 - 512
	Repeat on DMX	Enablement		Disabled Enabled on primary
		Universe		0 - 255
	Ethernet Interface	Control Protocol		Disabled Art-net on IP 2.x.x.x Art-net on IP 10.x.x.x
	Fixture ID			0 - 255

Main Menu	Level 1	Level 2	Level 3	Choices / Values	
OPTION	Pan / Tilt	Invert Pan		On / Off	
		Invert Tilt		On / Off	
		Swap Pan-Tilt		On / Off	
		Encoder Pan-Tilt		On / Off	
		P/T Homing mode		Standard Sequenced	
		Pan Home Def Pos		0 degree 90 degrees 180 degrees 270 degrees	
		Tilt Home Def Pos		0 % 12.5 % 25 % 50 % 75 % 87.5 % 100 %	
	Silent Mode			Standard Quiet	
	Fan Speed Mode			Auto Full	
	Display			On / Off	
	Special Functions	Pan/Tilt speed			Normal Fast
		Dimmer curve			Curve 1 Curve 2 Curve 3 Curve 4
		RGB Gamma			Gamma 1.0 Gamma 1.5 Gamma 2.0
		Halogen Mode			Halogen OFF Halogen Lamp 1 Halogen Lamp 2 Halogen Lamp 3 Halogen Lamp 4 Halogen Lamp 5
	Setting	Default Preset			Reset To Default Go Back
		User Preset 1			Load preset 1 Save to preset 1
		User Preset 2			Load preset 2 Save to preset 2
		User Preset 3			Load preset 3 Save to preset 3

Main Menu	Level 1	Level 2	Level 3	Choices / Values
INFORMATION	System Errors			Read / Reset
	Fixture Hours	Total Hours		Read
		Partial Hours		Read / Reset
	LED Energy Tot	Total Hours		Read
		Partial Hours		Read / Reset
	System Version	Aleda fw		Fw.rev.
		CPU board		Hw.rev.
		com.dev		Fw.rev.
		0:PT-3f		Fw.rev. / Hw.rev.
		1:Ld-k20		Fw.rev. / Hw.rev.
	Board Diagnostic	0:PT-3f		Status / Err%
		1:Ld-k20		Status / Err%
	DMX Monitor	Channels		Value / Percentage
	Fans Monitor	PwrSp		Speed (RPM)
		PwrSp		Speed (RPM)
		Head		Speed (RPM)
	Sensor Status	Pan		ON / OFF / n.a.
		Tilt		ON / OFF / n.a.
Zoom Rotation			ON / OFF / n.a.	
Zoom			ON / OFF / n.a.	
Network parameters	IP Address			
	IP Mask			
	MAC Address			
MANUAL CONTROL	Reset			Yes / No
	Channels			Value / Percentage
TEST	Pan / Tilt			
	Colour			
	Zoom			
	Rotation			
	All			
	Zoom Rotation Sensor Test			
ADVANCED	Access Code <u>1234</u>	Upload Firmware		Yes / No
		Setup Model		Yes / No
		Calibration	Channels	000 - 255
		LED calibration	LED Selection 01-37	Red 0-255 Green 0-255 Blue 0-255 White 0-255
			Reset To Default LED Calibration	

NOTE: On grey the default options

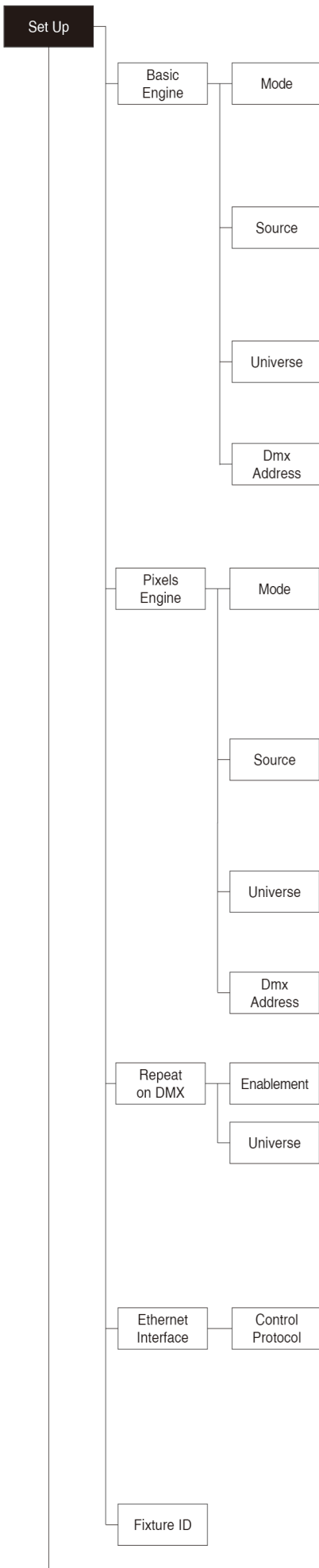

SET UP MENU

For greater programming ease using the DMX control unit and Media-server Art-net, channel mapping is divided into BASIC ENGINE and PIXEL ENGINE (see details in Channel Function).

BASIC ENGINE

Mode

This lets you select the projector operating mode for BASIC ENGINE, selecting one of the two available modes:

- Standard (see channel mapping in Channel Function)
- Shape (see channel mapping in Channel Function)

Source

It lets you assign the input source the projector receives signals from dedicated to BASIC ENGINE. One of the two available sources can be selected:

- DMX
- Art-net

Universe

It lets you set “DMX Universe” for BASIC ENGINE mode to assign values between 000 and 255 to a series of projectors (This option is valid only if Source= Art-net)

DMX Address

It lets you select the address (DMX Address) for the control signal by BASIC ENGINE. A DMX address between 001 and 512 can be selected.

NOTE: Without the DMX input signal, the displayed address (DMX Address) blinks.

PIXELS ENGINE

Mode

This lets you select the projector operating mode for PIXELS ENGINE, selecting one of the three available modes:

- Disabled
- RGB (see channel mapping in Channel Function)
- RGBW (see channel mapping in Channel Function)

Source

It lets you assign the input source the projector receives signals from dedicated to PIXELS ENGINE. One of the two available sources can be selected:

- DMX
- Art-net

Universe

It lets you set “DMX Universe” for PIXELS ENGINE mode to assign values between 000 and 255 to a series of projectors (This option is valid only if Source= Art-net)

DMX Address

It lets you select the address (DMX Address) for the control signal by PIXELS ENGINE. A DMX address between 001 and 512 can be selected.

REPEAT ON DMX

Enablement

It lets you enable/disable the transmission of the Ethernet protocol by DMX signal to all the connected projectors.

- Disabled: DMX transmission disabled.
- Enabled on primary: DMX transmission enabled.

Universe

It lets you set the “DMX Universe” to assign values between 000 and 255 to a series of projectors. In this case it refers to an Art-net input not read by the projector and re-transmitted to other projectors.

ETHERNET INTERFACE

It lets you set the Ethernet settings to be attributed to the projector.

Control Protocol

It lets you select the Art-net “Control Protocol” to be assigned according to the control unit used. The following options are available:

- Disabled
- Art-net on IP 2.x.x.x
- Art-net on IP 10.x.x.x

FIXTURE ID

It lets you set the “Fixture ID” to be assigned to the projector. An “ID” between 000 and 255 can be assigned.

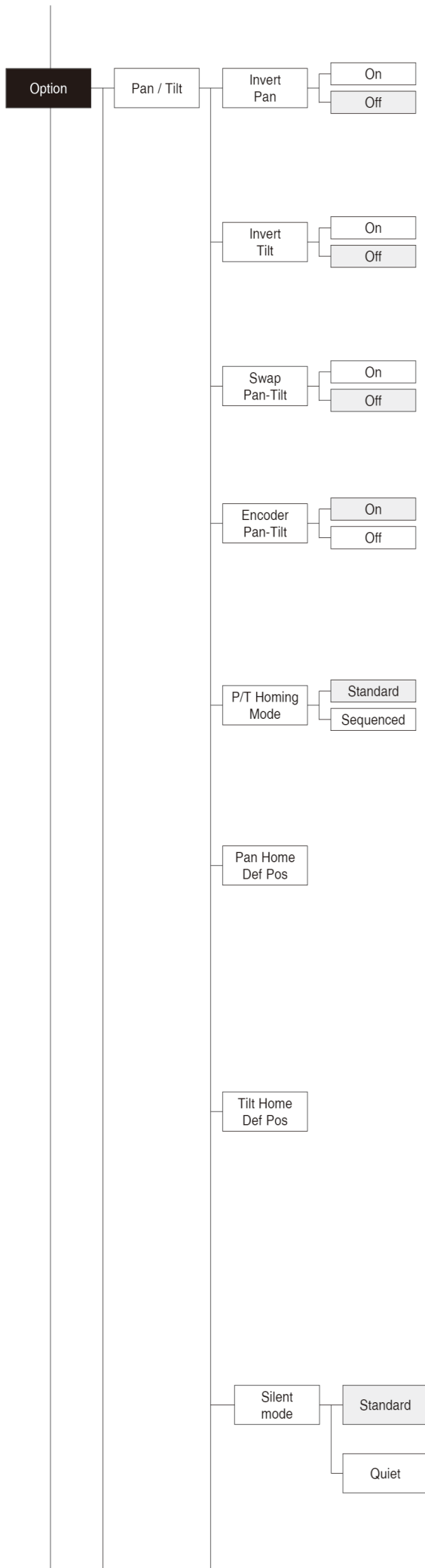

OPTIONS MENU

PAN / TILT

Invert pan

Used for reversing Pan movement.

- 1) Press **OK** - the current settings appear on the display (On or Off).
- 2) Use the UP **▲** and DOWN **▼** keys to enable (On) or disable (Off) PAN inversion.
- 3) Press **OK** to confirm the selection or LEFT **◀** to keep current settings.

Invert tilt

Used for reversing tilt movement.

- 1) Press **OK** - the current settings appear on the display (On or Off).
- 2) Use the UP **▲** and DOWN **▼** keys to enable (On) or disable (Off) Tilt inversion.
- 3) Press **OK** to confirm the selection or LEFT **◀** to keep current settings.

Swap Pan-Tilt

Used for swapping Pan and Tilt channels (as well as Pan fine and Tilt fine).

- 1) Press **OK** - the current settings appear on the display (On or Off).
- 2) Use the UP **▲** and DOWN **▼** keys to enable (On) or disable (Off) Pan and Tilt channel swap.
- 3) Press **OK** to confirm the selection or LEFT **◀** to keep current settings.

Encoder Pan-Tilt

Used for enabling the Pan / Tilt encoders.

- 1) Press **OK** - the current settings appear on the display (On or Off).
- 2) Use the UP **▲** and DOWN **▼** keys to enable (On) or disable (Off) Pan / Tilt encoders.
- 3) Press **OK** to confirm the selection or LEFT **◀** to keep current settings.

You can quickly disable the Pan and Tilt Encoder by simultaneously pressing the UP **▲ and DOWN **▼** keys in the "Main Menu".**

P/T Homing Mode

Lets you set the initial projector Reset mode.

- 1) Press **OK**, the current setting appears on the display.
- 2) Use the UP **▲** and DOWN **▼** keys to select one of the following settings:
 - Standard:** Pan & Tilt are simultaneously reset.
 - Sequenced:** Tilt is reset first followed by Pan.
- 3) Press **OK** to confirm the selection or LEFT **◀** to keep the current setting.

Pan Home Def Pos

Lets you assign the Pan channel "home" position at the end of Reset, without a DMX input signal.

- 1) Press **OK**, the current setting appears on the display.
- 2) Use the UP **▲** and DOWN **▼** keys to select one of the following settings:
 - 0 degree**
 - 90 degrees**
 - 180 degrees**
 - 270 degrees (default)**
- 3) Press **OK** to confirm the selection or LEFT **◀** to keep the current setting.

Tilt Home Def Pos

Lets you assign the Tilt channel "home" position at the end of Reset, without a DMX input signal.

- 1) Press **OK**, the current setting appears on the display.
- 2) Use the UP **▲** and DOWN **▼** keys to select one of the following settings:
 - 0%**
 - 12.5%**
 - 25%**
 - 50% (default)**
 - 75%**
 - 87.5%**
 - 100%**
- 3) Press **OK** to confirm the selection or LEFT **◀** to keep the current setting.

SILENT MODE

It lets you select the "Silent Mode" from the two available.

- 1) Press **OK** the current setting appears on the display.
- 2) Use the UP **▲** and DOWN **▼** keys to select one of the following settings:
 - Standard:** Maximum speed and consequently maximum effects/fans noise level.
 - Quiet:** Regulates the speed of the effects (Pan, Tilt, Zoom, Zoom rotation) and of the fans thereby reducing their noise level.
- 3) Press **OK** to confirm the selection or LEFT **◀** to keep the current setting.

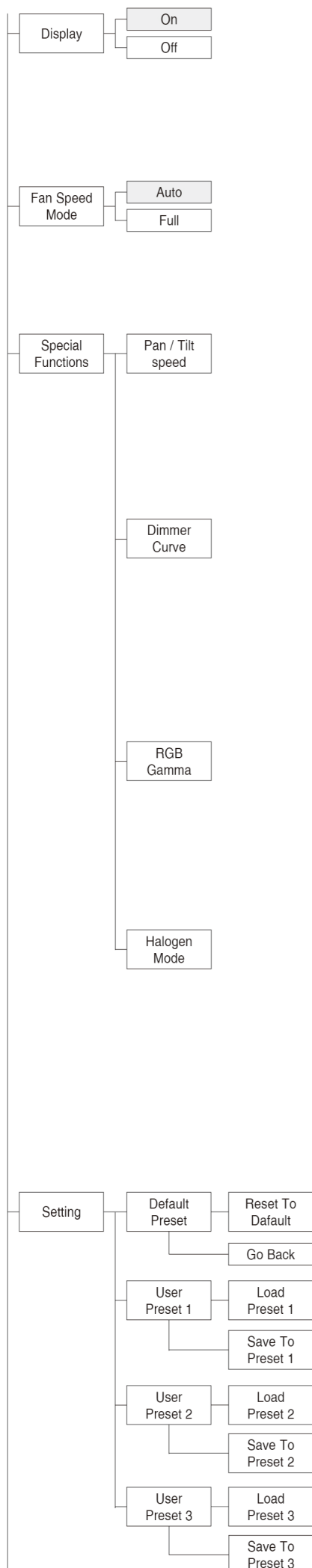

DISPLAY

Used for automatically reduce brightness on the display after about 30 seconds in idle.

- 1) Press **OK** - the current settings appear on the display (On or Off).
- 2) Use the UP **▲** and DOWN **▼** keys to enable (On) or disable (Off) the decreasing of display brightness.
- 3) Press **OK** to confirm the selection or LEFT **◀** to keep current settings.

FAN SPEED MODE

Allows you to set how to manage the fan speed of the head of the fixture, select between the two available:

- **Auto**: the head's fan varies the speed depending on the temperature detected on the LED.
- **Full**: the head's fan is always at full speed.

SPECIAL FUNCTIONS

Pan / Tilt speed

Lets you select two different Pan and Tilt speeds.

- 1) Press **OK** - the current setting appears on the display.
- 2) Use the UP **▲** and DOWN **▼** keys to select one of the following settings:
 - Normal
 - Fast
- 3) Press **OK** to confirm the selection or LEFT **◀** to keep current settings.

Dimmer Curve

Lets you select four different Dimmer channel curves.

- 1) Press **OK** - the current setting appears on the display.
- 2) Use the UP **▲** and DOWN **▼** keys to select one of the following settings:
 - Curve 1
 - Curve 2
 - Curve 3
 - Curve 4
- 3) Press **OK** to confirm the selection or LEFT **◀** to keep current settings.

RGB Gamma

Lets you select three different RGBW gamma curves.

- 1) Press **OK** - the current setting appears on the display.
- 2) Use the UP **▲** and DOWN **▼** keys to select one of the following settings:
 - Gamma 1.0
 - Gamma 1.5
 - Gamma 2.0
- 3) Press **OK** to confirm the selection or LEFT **◀** to keep current settings.

Halogen Mode

Lets you select five different halogen lamp simulations.



- 1) Press **OK** - the current setting appears on the display.
- 2) Use the UP **▲** and DOWN **▼** keys to select one of the following settings:
 - Halogen OFF
 - Halogen Lamp 1 - 750 W
 - Halogen Lamp 2 - 1000 W
 - Halogen Lamp 3 - 1200 W
 - Halogen Lamp 4 - 2000 W
 - Halogen Lamp 5 - 2500 W
- 3) Press **OK** to confirm the selection or LEFT **◀** to keep current settings.

SETTING

Used to save 3 different settings of the items in the options menu and relative submenus.

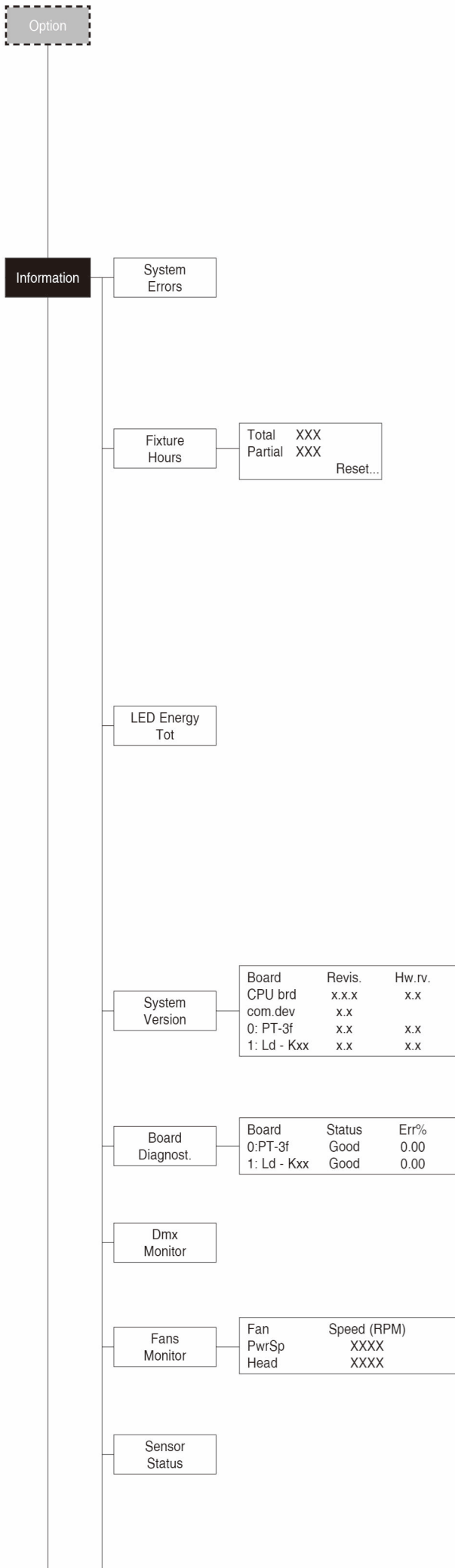
- 1) Press **OK** - "Default preset" appears on the display.
 - 2) Use the UP **▲** and DOWN **▼** keys to select one of the following configurations:
 - Default preset (*)
 - User preset 1
 - User preset 2
 - User preset 3
 - 3) Press **OK** - "Load preset X" appears on the display.
 - 4) Use the UP **▲** and DOWN **▼** keys to select:
 - Load preset X to recall a previously stored configuration.
 - Save to preset X to store the current configuration.
 a confirmation message (Are you sure?) appears on the display.
 - 5) Select YES to confirm the selection or NO to keep the current setting and return to the next higher level.
- (*) DEFAULT PRESET



By pressing the RIGHT  key and the LEFT  key simultaneously once entered in the "main menu" it is possible to quickly (short cut) reset the default settings (DEFAULT PRESET).

Used for restoring default values on all options menu items and relevant submenus.

- 1) Press  , a confirmation message (Are you sure?) appears on the display.
- 2) Select YES to confirm the selection or NO to keep current setting.

INFORMATION MENU

SYSTEM ERRORS

Shows a list of warnings and messages relevant to errors occurred since the fixtures switching-on.

- 1) Pressing  you are allowed to reset the SYSTEM ERRORS list.
A confirmation message (Are you sure you want to clear error list ?) appears on the display.
- 2) Select YES to reset the list or NO to go back.

FIXTURE HOURS

Used for displaying projector operating hours (total and partial).

- 1) Press  - Hours total and partial appears on the display.

Total counter

Counts the number of projector working life hours (from manufacture to date).

Partial counter

Counts the number of partial projector working life hours since the last reset to date.

- 2) Press  to reset partial projector working hours a confirmation message (Are you sure?) appears on the display.
- 3) Select YES to reset partial projectors counter or NO to keep the current setting and return to the top menu level.

LED ENERGY TOT

Lets you view total LED working hours.

- 1) Press  - to display total and partial Watts/hour:

Total

Total LED working hours from construction to date.

Partial

LED working hours from last reset to date.

- 2) Press  to reset the partial counter. A confirmation appears on the screen (Are you sure?)
- 3) Select YES to reset the partial counter or NO to keep the current setting and open the next menu level.

SYSTEM VERSION

Used for displaying the software and hardware version of each board installed in the projector.

CPU brd (CPU board)

0: PT-3f (Scheda Pan / Tilt)

1: Ld - Kxx (Scheda LED)

BOARD DIAGNOSTIC

Used for displaying the status error of each board installed in the projector:

0: PT-3f (Scheda Pan / Tilt)

1: Ld - Kxx (Scheda LED)

DMX MONITOR

Used for displaying the projector DMX channel level in bit (Val) and in percentage (Perc).

FANS MONITOR

Used for displaying the speed of each fan installed in the projector:

PwrSp (fan PSU)

Head (fan head)

SENSOR STATUS

It lets you check the correct operations of each "sensor" installed in the projector, each channel is associated with one of the following three parameters:

- n.a.= sensor not available
- ON= sensor working
- OFF= sensor defective

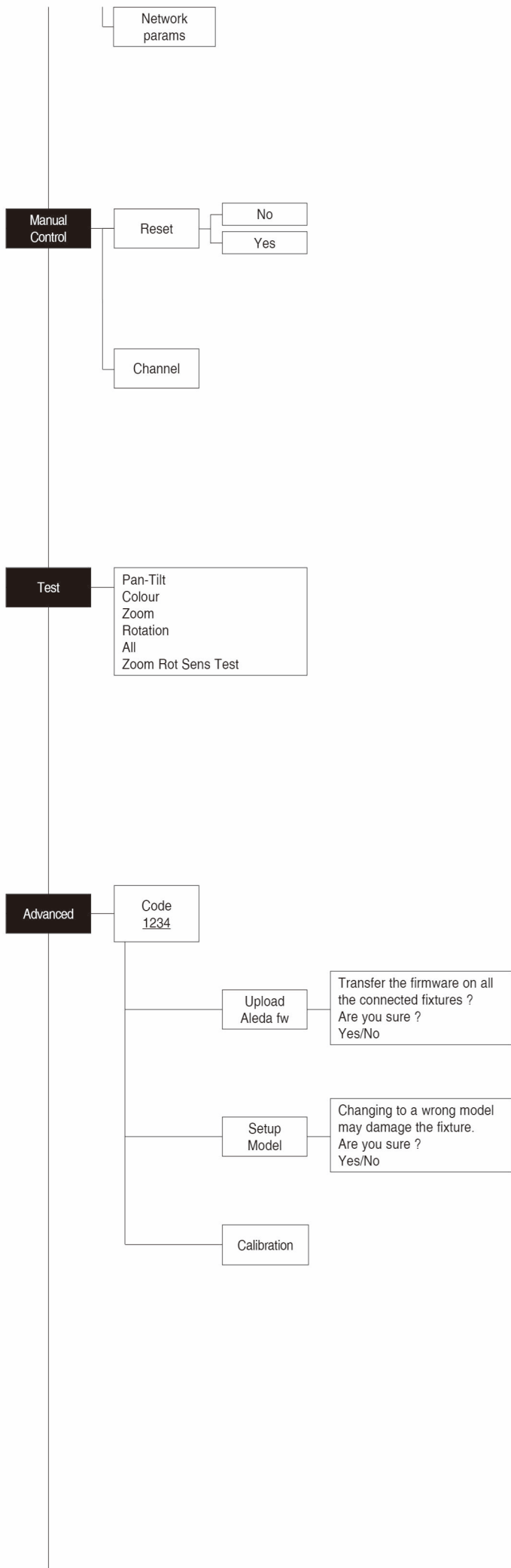

NETWORK PARAMS

Allows the "Network" parameters of the projector to be displayed or:

IP address: Internet Protocol address (two projectors must not have the same IP address)

IP mask: 255.0.0.0

Mac address: Media Access Control: the projector's Ethernet Address.

MANUAL CONTROL

RESET

Used for resetting the projector.

- 1) Press **OK** to reset the projectors, a confirmation message (Are you sure ?) appears on the display.
- 2) Select YES to starting reset the fixture or NO to keep the current setting and return to the top menu level.

CHANNEL

Used for setting channel levels from the projector control panel.

- 1) Press **OK** - the first channel appears on the display.
- 2) Use the UP **▲** and DOWN **▼** keys to select the required channel:
- 3) Press **OK** and use the UP **▲** and DOWN **▼** keys to select the required DMX level (value between 0 and 255).
- 4) Press LEFT **◀** to return to the top menu level.

TEST MENU

TEST

Allows you to check the proper functioning of effects.

- 1) Press **OK** to return to the top menu level.
- 2) Use the UP **▲** and DOWN **▼** keys to select the required test.
- 3) Press **OK** to confirm the selection or LEFT **◀** to keep current settings.

Test sequence:

Pan - Tilt effects (Pan & Tilt)

Colours

Zoom

Zoom rotation

All effects

Zoom Rotation Sensor Test

ADVANCED MENU

To enable the "Advanced Menu" set up the "Access code" (1234) using the UP **▲**, DOWN **▼**, RIGHT **▶** keys.

Press **OK** - "Menu advanced" appears on the display

UP LOAD FIRMWARE

Allows you to transfer the firmware from 1 fixture to all the connected fixtures.

- 1) Press **OK**, a confirmation message appears on the display.
- 2) Select YES to start the firmware loading or NO to keep the current setting and return to the top menu level

SETUP MODEL

Allows you to change the default model of projector.

- 1) Press **OK** a confirmation message appears on the display.
- 2) Select YES to define the model of projector or NO to keep the current setting and return to the top menu level.

CALIBRATION

Allows you to adjust effects from the control panel to obtain perfect uniformity between the projectors.

- 1) Press **OK** - "channels" appears on the display.
- 2) Using the UP **▲** and DOWN **▼** keys, select the effect you wish to regulate.
- 3) Press **OK** and use the RIGHT **▶**, UP **▲** and DOWN **▼** buttons to make the adjustment by setting a value between 0 and 255.
- 4) Press **OK** to confirm the selection or LEFT **◀** to keep current settings and return to the top level.

FACTORY DEFAULT

Allows you to restore default values of all channels (128).

- 1) Press **OK** - a confirmation message appears on the display (Reset calibration to factory default ?).
- 2) Select YES to reset calibration to factory default or NO to keep the current setting and return to the top menu level.

CHANNEL FUCTION

21CH (STANDARD)	
CHANNEL	FUNCTION
1	Red
2	Red fin
3	Green
4	Green fine
5	Blue
6	Blue fine
7	White
8	White fine
9	Linear CTO
10	Macro color
11	Strobe
12	Dimmer
13	Dimmer fine
14	Pan
15	Pan fine
16	Tilt
17	Tilt fine
18	Function
19	Reset
20	Zoom
21	Zoom Rotation

35CH (SHAPES)	
CHANNEL	FUNCTION
1	Red
2	Red fin
3	Green
4	Green fine
5	Blue
6	Blue fine
7	White
8	White fine
9	Linear CTO
10	Macro color
11	Strobe
12	Dimmer
13	Dimmer fine
14	Pan
15	Pan fine
16	Tilt
17	Tilt fine
18	Function
19	Reset
20	Zoom
21	Zoom Rotation
22	Shape Selection
23	Shape Speed
24	Shape Fade
25	Shape R
26	Shape G
27	Shape B
28	Shape W
29	Shape Dimmer
30	Background Dimmer
31	Shape Transition
32	Shape offset
33	Foreground Strobe
34	Background Strobe
35	Background Select

78CH (EXTENDED)	
CHANNEL	FUNCTION
1	Red
2	Red fin
3	Green
4	Green fine
5	Blue
6	Blue fine
7	White
8	White fine
9	Linear CTO
10	Macro color
11	Strobe
12	Dimmer
13	Dimmer fine
14	Pan
15	Pan fine
16	Tilt
17	Tilt fine
18	Function
19	Reset
20	Zoom
21	Zoom Rotation
22	LED1 R
23	LED1 G
24	LED1 B
...	... R
...	... G
...	... B
76	LED19 R
77	LED19 G
78	LED19 B

Simple Channel

97CH (EXTENDED RGBW)	
CHANNEL	FUNCTION
1	Red
2	Red fine
3	Green
4	Green fine
5	Blue
6	Blue fine
7	White
8	White fine
9	Linear CTO
10	Macro color
11	Strobe
12	Dimmer
13	Dimmer fine
14	Pan
15	Pan fine
16	Tilt
17	Tilt fine
18	Function
19	Reset
20	Zoom
21	Zoom Rotation
22	LED1 R
23	LED1 G
24	LED1 B
25	LED1 W
...	... R
...	... G
...	... B
...	... B
94	LED19 R
95	LED19 G
96	LED19 B
97	LED19 W

92CH (FULL)	
CHANNEL	FUNCTION
1	Red
2	Red fine
3	Green
4	Green fine
5	Blue
6	Blue fine
7	White
8	White fine
9	Linear CTO
10	Macro color
11	Strobe
12	Dimmer
13	Dimmer fine
14	Pan
15	Pan fine
16	Tilt
17	Tilt fine
18	Function
19	Reset
20	Zoom
21	Zoom Rotation
22	Shape Selection
23	Shape Speed
24	Shape Fade
25	Shape R
26	Shape G
27	Shape B
28	Shape W
29	Shape Dimmer
30	Background Dimmer
31	Shape Transition
32	Shape offset
33	Foreground Strobe
34	Background Strobe
35	Background Select
36	LED1 R
37	LED1 G
38	LED1 B
...	... R
...	... G
...	... B
90	LED19 R
91	LED19 G
92	LED19 B

NOTE: On conclusion of resetting in case of absence of DMX signal, Pan & Tilt move to the "Home" position (Pan 128 bit - Tilt 128 bit) all the others channels stay at 0 bit.

• RED
GREEN
BLUE
WHITE



BIT	EFFECT
255	LED ON
0	LED OFF

• RED FINE
GREEN FINE
BLUE FINE
WHITE FINE



BIT	EFFECT
255	UP
0	LOW

• LINEAR CTO

BIT	EFFECT
255	2500 K
...	...
224	3200 K
...	...
188	4000 K
...	...
144	5000 K
...	...
117	5600 K
...	...
99	6000 K
...	...
54	7000 K
...	...
10	8000 K
0-9	UNUSED RANGE

Note: If CTO channel is active, the WHITE channel is disabled.

• MACRO COLOUR

BIT	LEE REFERENCE	COLOUR	BIT VALUE			
			R	G	B	W
209-255	-	White	255	235	66	255
208	-	Dirty White	255	255	122	255
207	197	Alice Blue	128	255	143	0
191-206	181	Congo Blue	77	0	255	0
184-190	174	Dark Steel Blue	181	255	95	0
180-183	170	Deep lavender	255	168	64	0
179	169	Lilac Tint	255	199	49	0
175-178	165	Daylight Blue	82	214	90	0
174	164	Flame Red	255	46	2	0
172-173	162	Bastard Amber	255	181	28	0
168-171	158	Deep Orange	222	84	0	0
162-167	152	Pale Gold	253	171	26	0
157-161	147	Apricot	255	143	13	0
151-156	141	Bright Blue	0	255	87	0
149-150	139	Primary Green	77	255	0	0
147-148	137	Special lavender	219	197	79	0
146	136	Pale Lavender	255	197	61	0
145	135	Deep Golden Amber	255	58	0	0
142-144	132	Medium Blue	0	255	143	0
138-141	128	Bright Pink	255	53	36	0
136-137	126	Mauve	227	41	56	0
134-135	124	Dark Green	84	255	13	0
131-133	121	Leaf Green	206	255	0	0
129-130	119	Dark Blue	0	186	255	0
128	118	Light Blue	74	255	82	0
127	117	Steel Blue	206	255	56	0
126	116	Med Blu Green	206	255	56	0
125	115	Peacock Blue	51	255	51	0
123-124	113	Magenta	255	20	15	0
121-122	111	Dark Pink	255	109	33	0
120	110	Middle Rose	217	130	28	0
119	109	Light Salmon	255	138	31	0
118	108	English Rose	255	148	23	0
117	107	Light Rose	255	141	31	0
115-116	105	Orange	255	122	0	0
114	104	Deep Amber	255	166	0	0
113	103	Straw	230	160	0	69
112	102	Light Amber	237	163	0	0
110-111	100	Spring Yellow	245	202	0	0
100-109	90	Dark yellow green	41	219	0	0
89-99	79	Just Blue	0	194	130	0
78-88	68	Sky Blue	0	255	135	0
68-77	58	Lavender	243	117	133	199
62-67	52	Light Lavender	243	117	39	197
49-61	39	Pink Carnation	255	107	0	130
46-48	36	Medium Pink	255	87	0	107
45	35	Light Pink	255	112	0	141
35-44	25	Sunrise Red	255	83	2	0
32-34	22	Dark Amber	255	65	0	0
31	21	Gold Amber	255	100	0	0
30	20	Medium Amber	255	135	0	0
29	19	Fire	255	56	0	0
27-28	17	Surprise Peach	198	114	9	0
23-26	13	Straw Tint	152	115	9	0
20-22	10	Medium Yellow	156	126	0	0
19	-	Black	0	0	0	0
18	-	White 5000 K	255	137	0	193
17	-	White 3700 K	255	201	25	255
16	-	White 7000 K	216	237	61	255
15	-	Magenta	255	0	255	0
14	-	Yellow	255	255	0	0
13	-	Cyan	0	255	255	0
12	-	Blue	0	0	255	0
11	-	Green	0	255	0	0
10	-	Red	255	0	0	0
0-9	-	Macro color OFF	-	-	-	-

• STOP STROBE - FOREGROUND STROBE - BACKGROUND STROBE



BIT	EFFECT
252 - 255	OPEN
239 - 251	RANDOM FAST STROBE
226 - 238	RANDOM MEDIUM STROBE
213 - 225	RANDOM SLOW STROBE
208 - 212	OPEN
207	FAST PULSATION (25 flash/sec)
108	SLOW PULSATION (0,5 flash/sec)
104 - 107	OPEN
103	FAST STROBE (25 flash/sec)
4	SLOW STROBE (1 flash/sec)
0 - 3	CLOSED

• TILT

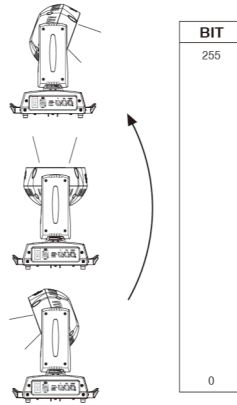

• TILT FINE

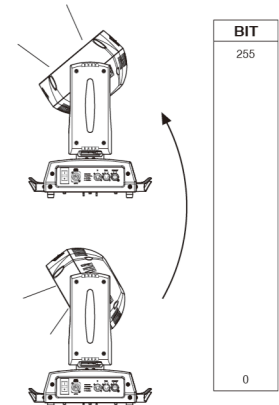

Operation with option InvertTilt \diamond Off

• DIMMER

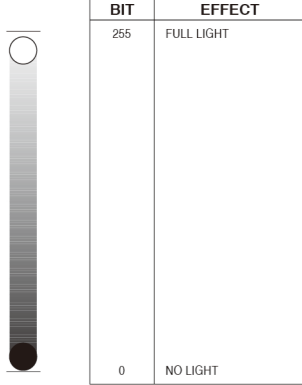

• DIMMER FINE

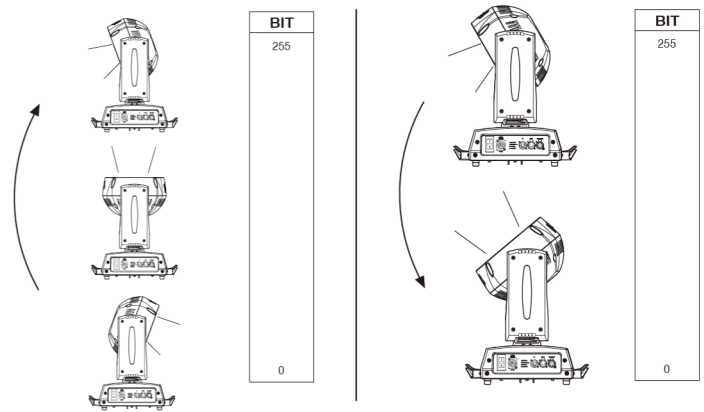
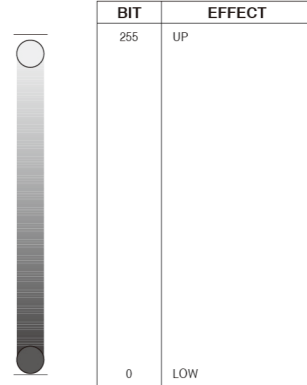

Operation with option InvertTilt \diamond On

• PAN

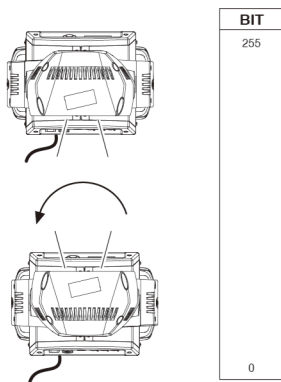

Operation with option InvertPan \diamond Off

• PAN FINE

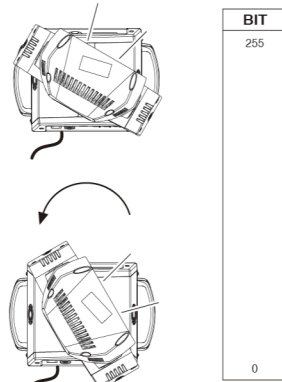

• FUNCTION

BIT	EFFECT
106 - 255	Reserved
103 - 105	Pixel map enabled
98 - 102	Halogen Lamp Simulation Linear CTO @ 0 bit
93 - 97	Halogen Lamp Simulation Linear CTO @ 0 bit
88 - 92	Halogen Lamp Simulation Linear CTO @ 0 bit
83 - 87	Halogen Lamp Simulation Linear CTO @ 0 bit
78 - 82	Halogen Lamp Simulation Linear CTO @ 0 bit
73 - 77	Halogen Lamp Simulation OFF (Default)
68 - 72	RGBW Gamma curve 3 - gamma = 2.0
63 - 67	RGBW Gamma curve 2 - gamma = 1.5
58 - 62	RGBW Gamma curve 1 - gamma = 1.0
52 - 57	Dimmer Curve 4
48 - 52	Dimmer Curve 3
43 - 47	Dimmer Curve 2
38 - 42	Dimmer Curve 1
24 - 37	Pan Tilt Normal
12 - 24	Pan Tilt Fast (Default)
0 - 11	Function off - rearmed

The functions are activated passing through the "unused range" and staying 5 seconds in necessary level.

Last selected function still active. Enable setting a new function.

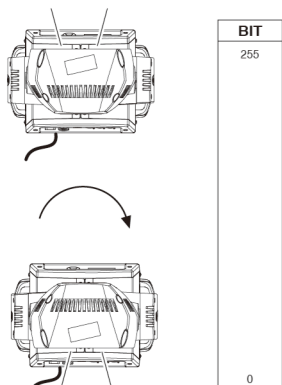

Operation with option InvertPan \diamond On

DIMMER CURVE 1 - GAMMA 1 LINEAR

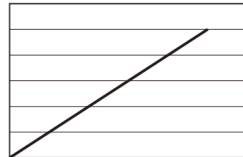

DIMMER CURVE 3 - GAMMA 2,0

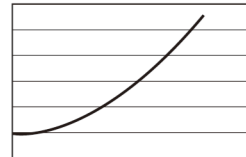

DIMMER CURVE 2 - GAMMA 1,5

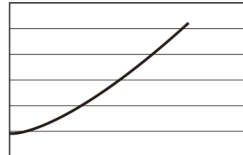

DIMMER CURVE 4 - S

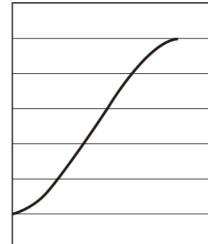

• **RESET**

BIT	EFFECT
255	COMPLETE RESET Complete reset is activated passing through the unused range and staying 5 seconds in complete reset levels
128 127	COMPLETE RESET PAN / TILT RESET Pan / Tilt reset is activated passing through the unused range and staying 5 seconds in Pan / Tilt reset levels
77 76	PAN / TILT RESET ZOOM RESET Effects reset is activated passing through the unused range and staying 5 seconds in Effects reset levels.
26 25	ZOOM RESET
0	UNUSED RANGE

• **ZOOM**



BIT	EFFECT
255	WIDE BEAM
0	NARROW BEAM

• **ZOOM ROTATION**

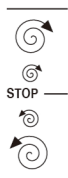

BIT	EFFECT
255	FAST ROTATION
193	SLOW ROTATION
191 - 192	STOP
190	SLOW ROTATION
128	FAST ROTATION
127	FAST ROTATION
0	LINEAR ROTATION

• **ZOOM ROTATION (available on zoom channel from 0 bit to 42 bit)**

BIT	MACRO EFFECT
193-255	CCW Rotation, speed from 3 RPH to 10 RPM
191-192	Stop rotation
128-190	CW Rotation, speed from 10 RPM to 3 RPH
127	Indexed zone. Lens angle = 60.00
126	Indexed zone. Lens angle = 59.52
....	
3	Indexed zone. Lens angle = 1.42
2	Indexed zone. Lens angle = 0.94
1	Indexed zone. Lens angle = 0.47
0	Indexed zone. Lens angle = 0

• **ZOOM ROTATION (available on zoom channel at 255 bit only)**

BIT	MACRO EFFECT
128-255	Lens offset angle: 0.00 degree
127	Lens offset angle: +4.00 degree
126	Lens offset angle: +3.94 degree
125	Lens offset angle: +3.87 degree
....	
1	Lens offset angle: +0.06 degree
0	Lens offset angle: 0.00 degree

- RED LED 1 to...
- GREEN LED 1 to...
- BLUE LED 1 to...
- WHITE LED 1 to...



BIT	EFFECT
255	LED ON
0	LED OFF

SHAPE SPEED - SHAPE OFFSET - SHAPE FADE - BACKGROUND SELECT

Shape Selection	Shape Slot	Macro Name	On K10	On K20	Description	Random colors *1	SHAPE SPEED	SHAPE OFFSET	SHAPE FADE	BACKGROUND SELECT (*3)(*4)
0-7		Macro OFF	Yes	Yes		N.a.	N.a.	N.a.	N.a.	N.a.
8	1	Pixel 1	Yes	Yes	Static effects. The ring or rings used by the macro are turned-on with the foreground colour.	N.a.	N.a.	N.a.	0-15 = Snap effect 16-255 = Fade effect and gamma selection	For K10: 0-7 = wash 8-15 = Bkgnd rings selection 16-255 = wash For K20: 0-7 = wash 8-23 = Bkgnd rings selection 24-255 = wash
9	2	Ring 1	Yes	Yes						
10	3	Ring 2	Yes	Yes						
11	4	Ring 3	No	Yes						
12	5	Pixel 1+Ring 1	Yes	Yes						
13	6	Pixel 1+Ring 2	Yes	Yes						
14	7	Pixel 1+Ring 3	No	Yes						
15	8	Single ring (Ramp -/+)	Yes	Yes		Yes	0-63 = Radius size, static. 64-158 = max to min speed, Closing effect 159-160 = STOP 161-255 = min to max speed, Opening effect	0-9 → continuous 10-255 → random distribution of flash	0-15 = Snap effect 16-255 = Fade effect and gamma selection	For K10: 0-7 = wash 8-15 = Bkgnd rings selection 16-255 = wash For K20: 0-7 = wash 8-23 = Bkgnd rings selection 24-255 = wash
16	9	Filled rings (ramp -/+)	Yes	Yes	Yes					
17	10	Open/Close 1	Yes	Yes	Yes					
18	11	Open/Close 2	Yes	Yes	Yes					
19	12	Random pixels 1	Yes	Yes		Yes	0-63 = Radius size, static. 64-158 = max to min speed, Closing effect 159-160 = STOP 161-255 = min to max speed, Opening effect	0-255 → select random distribution from 2 up to 20 fixtures	0-15 = Snap effect 16-255 = Fade effect and gamma selection	For K10: 0-7 = wash 8-15 = Bkgnd rings selection 16-254 = wash For K20: 0-7 = wash 8-23 = Bkgnd rings selection 24-254 = wash All Fixtures: 255 = Mirror Effect
20	13	Random pixels 2	Yes	Yes		Yes	0-63 = STOP 64-158 = max to min speed, Instant-on + fadeout. 159-160 = STOP. 161-255 = min to max speed, FadeIn + FadeOut.	0-255 → select pixel density		
21	14	Rainbow 1 (Variable speed)	Yes	Yes		N.a.	0-63 = Angle 0-360°, static. 64-158 = max to min speed, c.cw rotation 159-160 = STOP 161-255 = min to max speed, cw rotation	0-255 → angle offset from 0 to 360°	0-15 = Snap effect 16-255 = Fade effect and gamma selection	For K10: 0-7 = wash 8-15 = Bkgnd rings selection 16-255 = wash For K20: 0-7 = wash 8-23 = Bkgnd rings selection 24-255 = wash
22	15	Rainbow 2 (Fixed speed with variable color offset)	Yes	Yes		N.a.	0-63 = STOP 64-158 = c.cw rotation 159-160 = STOP 161-255 = cw rotation The value 64-158 or 161-255 change the rainbow angle offset (the orange starting angle).	N.a.	0-15 = Snap effect 16-255 = Fade effect and gamma selection	For K10: 0-7 = wash 8-15 = Bkgnd rings selection 16-255 = wash For K20: 0-7 = wash 8-23 = Bkgnd rings selection 24-255 = wash
23	16	Fan	Yes	Yes		N.a.	0-63 = angle offset, 0-360° 64-158 = max to min speed, c.cw rotation 159-160 = STOP 161-255 = min to max speed, cw rotation	0-255 → angle offset from 0 to 360°	0-15 = Snap effect 16-255 = Fade effect and gamma selection	For K10: 0-7 = wash 8-15 = Bkgnd rings selection 16-255 = wash For K20: 0-7 = wash 8-23 = Bkgnd rings selection 24-255 = wash For all fixtures: - Macro 25, 26 255 = Mirror Effect with bkgnd color - Macro 27, 28, 29 255 = Show Alternative Color
24	17	Bar 1	Yes	Yes						
25	18	Half moon	Yes	Yes						
26	19	Triangle	Yes	Yes						
27	20	Segment 1	Yes	Yes						
28	21	Arc 1	Yes	Yes						
29	22	Arc 2	Yes	Yes						

Shape Selection	Shape Slot	Macro Name	On K10	On K20	Description	Random colors *1	SHAPE SPEED	SHAPE OFFSET	SHAPE FADE	BACKGROUND SELECT (*3)(*4)	
30	23	Bar 2 (Variable size)	Yes	Yes		N.a.	0-63 = STOP, indexed speed 64-158 = max to min speed, c.w rotation. 159-160 = STOP. 161-255 = min to max speed cc rotation.	0-255 → select shape width	Linear fade	For K10: 0-7 = wash 8-15 = Bkgnd rings selection 16-254 = wash 255 = Mirror effect with bkgnd color For K20: 0-7 = wash 8-23 = Bkgnd rings selection 24-254 = wash 255 = Mirror effect with bkgnd color Note: Mirror effect unavailable for macro 31. Macro 67, 68, 69: the mirror effect is available only for options 1, 3, 9	
31	24	Random explosion	Yes	Yes		Yes		0-255 → select random distribution	Linear fade and wake length		
32	25	Segment 2	Yes	Yes				0-255 → select shape width			
33	26	x Bump	No	Yes				0-255 → select macro offset	Linear fade		
34	27	Image	No	Yes							
35	28	Bumping section	Yes	Yes							
36	29	Ramp by 6	Yes	Yes				0-255 → select shape width	Linear fade and wake length		
37	30	Ramp by 4	Yes	Yes							
38	31	Left/Right scrolling bar	Yes	Yes							
39	32	Up/Down scrolling bar	Yes	Yes							
40	33	Bar 3	Yes	Yes				0-255 → select macro offset	Linear fade		
41	34	Vertical arc 1	No	Yes							
42	35	Vertical arc 2	Yes	Yes							
43	36	Horizontal arc 1	No	Yes							
44	37	Horizontal arc 2	Yes	Yes							
45	38	Mirrored pixel	Yes	Yes				0-255 → select shape width	Linear fade and wake length		
46	39	Pixel animation 1	Yes	Yes							
47	40	Pixel animation 2	Yes	Yes							
48	41	Pixel animation 3	Yes	Yes							
49	42	Pixel animation 4	Yes	Yes							
50	43	Pixel animation 5	Yes	Yes							
51	44	Semi arc (Ramp /+)	Yes	Yes							
52	45	Bumping arc section	Yes	Yes				0-255 → select macro offset	Linear fade		
53	46	Pixel animation 6	Yes	Yes							
54	47	Vertical ramp by 2	Yes	Yes				0-255 → select shape width	Linear fade and wake length		
55	48	Following pixel by 2	Yes	Yes							
56	49	Syncopation	Yes	Yes				0-255 → select macro offset	Linear fade		
57	50	Bumping 1	Yes	Yes							
58	51	Bumping 2	Yes	Yes							
59	52	Bumping 3	Yes	Yes							
60	53	Vertical pixel scrolling	Yes	Yes				0-255 → select macro width	Linear fade and wake length		
61	54	Random vertical section	Yes	Yes				0-255 → select random distribution	Linear fade		
62	55	Random central section	Yes	Yes		Yes					
63	56	Random ring 2	Yes	Yes		Yes					
64	57	Random ring 3	No	Yes		Yes					
65	58	Random ring 1+3	Yes (*2)	Yes		Yes					
66	59	Random ring 2+3	Yes (*2)	Yes		Yes					
67	60	Single pixel ring 1	Yes	Yes				0-255 → select the number of rotating	Linear fade and wake length		
68	61	Single pixel ring 2	Yes	Yes							
69	62	Single pixel ring 3	No	Yes							
70	63	Spiral	Yes	Yes				0-255 → select macro width	Linear fade and wake length		
71-255	64					N.a.		N.a.	N.a.		N.a.

• SHAPE FADE

BIT	EFFECT
246-255	Smooth, fading curve with automatic gamma *
245	Smooth, fading curve gamma 2
243	Smooth, fading curve gamma 1,986
244	Smooth, fading curve gamma 1,993
...	
18	Smooth, fading curve gamma 0.513
17	Smooth, fading curve gamma 0.506
16	Smooth, fading curve gamma 0,5
0-15	Snap

• SHAPE TRANSITION

BIT	EFFECT
255	4 sec
...	
216	3 sec
...	
171	2 sec
...	
113	1 sec
...	
73	0,5 sec
...	
5	100 ms
0-4	No fade

• SHAPE RGBW
SHAPE DIMMER
BACKGROUND DIMMER



BIT	EFFECT
255	LED ON
...	
0	LED OFF

Background select

BIT	EFFECT
24-255	No selection
...	
23	Pixel 1 + Ring 2 + Ring 4
22	Pixel 1 + Ring 3 + Ring 4
21	Ring 2 + Ring 4
20	Pixel 1 + Ring 3
19	Ring 2 + Ring 3
18	Pixel 1 + Ring 4
17	Ring 3 + Ring 4
16	Ring 2 + Ring 3 + Ring 4
15	Pixel 1 + Ring 2 + Ring 3 + Ring 4
14	Pixel 1 + Ring 2 + Ring 3
13	Pixel 1 + Ring 2
12	Ring 4
11	Ring 3
10	Ring 2
9	Pixel 1
8	No selection